



THE RELIABLE SOURCE  
SINCE 1985

**2019**

# VIBEPROOF

Prevent and avoid costly service calls with Magic Plastics' new Vibeproof™ Locking Union Technology.

The Patent Pending design incorporates the use of a series of strategically placed Scallops on the Pump Union Nut and Tailpiece; hand tightening the nut will engage the lock, preventing the Union from loosening or backing out during vibration. The Vibeproof™ locking feature is available in a variety of Magic Plastics' products including Pump Unions, Smart® Check Valves, Uni-Body Valves, Unions and High Heat Union Assemblies.



Magic Plastics, Incorporated • 25215 Avenue Stanford • Valencia, CA 91355 USA  
(661) 257-4485 • Toll-Free (800) 369-0303 • Fax: (661) 257-1911  
[www.magicplastics.com](http://www.magicplastics.com) • email: [sales@magicplastics.com](mailto:sales@magicplastics.com)

**MAGIC**  
P L A S T I C S  
*Believe in Magic.*

# TABLE OF CONTENTS

“Smart” Check® Valves	4-5
Retro “Smart” Check® Valves	5
Metric “Smart” Check® Valves	6
Hose Clamp “Smart” Check® Valves	6
Slide-Check & Ball-Check Combo Valves	6
“CR2®” Corrosion Resistant Check Valves	7
Check Valve Replacement Components	7
Utility Molded In Place (MIP) Ball Valves	8
Uni-Body Valves	8-10
Metric Uni-Body Valves	10
Spa On/Off Valves	10
External Valve Locks (MagicSnap)	11
Spa Drain Valves	11
Compact Air Check Valves	12
MagicVac	12
90° Sweeps	13
Spa Components and White Goods	13
Manifolds	14
MagicMend® Pipe Extenders (Schedule 40)	15
MagicMend® Pipe Extenders (CL 200)	15
MagicMend® Extender Fittings	15
MagicMend® Insider Connectors	16
Copper-To-PVC Adapters	16
Heater-Pump Adapters	16
Union Assemblies	17
High Heat Union Assemblies	17-18
Union Components	18
Snap Nuts	19
Heater Union Components	19
Three-Piece Valves	20
Tank Adapter Valves	20
Specialty Products	21
Hose Bibbs	22
PVC Industrial Unions	22
Expandable Repair Couplings	23
Compression Couplings	23
O-Rings	24
Washer Rings	24
Magic Wrench	24
Replacement Components	25
I.B.C. (Intermediate Bulk Container) Products	26

## “Smart” Check® Valves

The “Smart” Check® provides you with reliable back-flow prevention without the inline restriction of a conventional check valve. With the use of high powered magnets, the “Smart” Check valve remains in the closed position to 2 PSI, opening fully when 2 lb. line pressure is exceeded. The “Smart” Check has a Spring-Loaded gate mechanism allowing the valve to be installed in any orientation. The valve is also available in a non-magnetic, ½ lb. Spring-Loaded version.

Available in ½” through 3” IPS sizes. The “Smart” Check Valves are rated at 150 PSI at 73°F. All “Smart” Check Valves are also available as a Swing-Check, without Spring. Minimum order quantities apply. Please contact the factory direct for details.



PART NUMBER	SIZE & DETAIL DESCRIPTION	SPRING TENSION	IPS SIZE	QTY CASE	WT CASE
<b>0821-05</b>	½” Slip x Slip	½ lb.	½”	12	5
<b>0821-05C</b>	½” Slip x Slip Clear	½ lb.	½”	12	5
<b>0826-05</b>	½” FIPT x FIPT	½ lb.	½”	12	5
<b>0826-05C</b>	½” FIPT x FIPT Clear	½ lb.	½”	12	5
<b>0821-07</b>	¾” Slip x Slip	½ lb.	¾”	12	5
<b>0821-07C</b>	¾” Slip x Slip Clear	½ lb.	¾”	12	5
<b>0826-07</b>	¾” FIPT x FIPT	½ lb.	¾”	12	5
<b>0826-07C</b>	¾” FIPT x FIPT Clear	½ lb.	¾”	12	5
<b>0821-10</b>	1” Slip x Slip	½ lb.	1”	12	8
<b>0821-10C</b>	1” Slip x Slip Clear	½ lb.	1”	12	8
<b>0821-15</b>	1½” Slip x Slip	½ lb.	1 ½”	12	9
<b>0821-15C</b>	1½” Slip x Slip Clear	½ lb.	1 ½”	12	9
<b>0821-20</b>	2” Slip x Slip	½ lb.	2”	12	13
<b>0821-20C</b>	2” Slip x Slip Clear	½ lb.	2”	12	13
<b>0821-20M</b>	2” Slip x Slip w/Magnet	2 lb.	2”	12	14
<b>0821-20MC</b>	2” Slip x Slip w/Magnet Clear	2 lb.	2”	12	14
<b>0821-30</b>	3” Slip x Slip	½ lb.	3”	8	22
<b>0821-30C</b>	3” Slip x Slip Clear	½ lb.	3”	8	22



<b>0822-20</b>	2” Spigot x Slip	½ lb.	2”	12	13
<b>0822-20C</b>	2” Spigot x Slip Clear	½ lb.	2”	12	13
<b>0822-20M</b>	2” Spigot x Slip w/Magnet	2 lb.	2”	12	14
<b>0822-20MC</b>	2” Spigot x Slip w/Magnet Clear	2 lb.	2”	12	14

## “Smart” Check® Valves

**WIDE PROOF**



**WIDE PROOF**



**WIDE PROOF**



PART NUMBER	SIZE & DETAIL DESCRIPTION	SPRING TENSION	IPS SIZE	QTY CASE	WT CASE
<b>0823-10</b>	1" Union x Union	½ lb.	1"	12	10
<b>0823-10C</b>	1" Union x Union Clear	½ lb.	1"	12	10
<b>0823-12</b>	1¼" Union x Union	½ lb.	1¼"	12	11
<b>0823-12C</b>	1¼" Union x Union Clear	½ lb.	1¼"	12	11
<b>0823-15</b>	1½" Union x Union	½ lb.	1½"	12	13
<b>0823-15C</b>	1½" Union x Union Clear	½ lb.	1½"	12	13
<b>0823-20</b>	2" Union x Union	½ lb.	2"	12	25
<b>0823-20C</b>	2" Union x Union Clear	½ lb.	2"	12	25
<b>0823-20M</b>	2" Union x Union w/Magnet	2 lb.	2"	12	26
<b>0823-20MC</b>	2" Union x Union w/Magnet Clear	2 lb.	2"	12	26

<b>0824-20</b>	2" Spigot x Union	½ lb.	2"	12	20
<b>0824-20C</b>	2" Spigot x Union Clear	½ lb.	2"	12	20
<b>0824-20M</b>	2" Spigot x Union w/Magnet	2 lb.	2"	12	21
<b>0824-20MC</b>	2" Spigot x Union w/Magnet Clear	2 lb.	2"	12	21

<b>0825-15</b>	1½" Slip x Union	½ lb.	1½"	12	11
<b>0825-15C</b>	1½" Slip x Union Clear	½ lb.	1½"	12	11
<b>0825-20</b>	2" Slip x Union	½ lb.	2"	12	20
<b>0825-20C</b>	2" Slip x Union Clear	½ lb.	2"	12	20
<b>0825-20M</b>	2" Slip x Union w/Magnet	2 lb.	2"	12	21
<b>0825-20MC</b>	2" Slip x Union w/Magnet Clear	2 lb.	2"	12	21

## Retro “Smart” Check® Valves

Switch out and upgrade old style restrictive Center-Poppet Spring or old style Swing Check Acme Threaded valves with Magic Plastics' Retro Replacement Smart Check® Valve Bodies. There is no longer a need to purchase the entire valve assembly and discard the Union Fittings. Magic's Retro is sold separately as a replacement body in 1½" and 2" sizes. Most importantly, you get the same Full-Flow design as Magic Plastics' innovative and popular Smart Check® Valves. The light ½ lb. spring allows you to install the valve in any orientation while still achieving a 100% Full-Flow opening.



PART NUMBER	SIZE & DETAIL DESCRIPTION	SPRING TENSION	IPS SIZE	QTY CASE	WT CASE
<b>0823-15RT</b>	1½" Union x 1½" Union Retro Ck. Valve	½ lb.	1½"	12	10
<b>0823-15RTC</b>	1½" Union x 1½" Union Retro Ck. Valve Clear	½ lb.	1½"	12	10
<b>0823-20RT</b>	2" Union x 2" Union Retro Check Valve	½ lb.	2"	12	14
<b>0823-20RTC</b>	2" Union x 2" Union Retro Ck. Valve Clear	½ lb.	2"	12	14

Unions not included.



## Metric “Smart” Check® Valves

**WATERPROOF**



PART NUMBER	SIZE & DETAIL DESCRIPTION	SPRING TENSION	IPS SIZE	QTY CASE	WT CASE
<b>M823-15</b>	50MM Union x Union	½ lb.	50mm	12	13
<b>M823-15C</b>	50MM Union x Union Clear	½ lb.	50mm	12	13
<b>M823-20</b>	63MM Union x Union	½ lb.	63mm	12	25
<b>M823-20C</b>	63MM Union x Union Clear	½ lb.	63mm	12	25

## Hose Clamp Check Valves

Simplify your installation with Magic Plastics’ Hose Clamp Check Valves. There is no need to solvent weld, just secure the Hose Clamps with a screwdriver. The innovative design of the Smart Check® Valve will eliminate water hammer noise and also allows you to install the valve in any orientation. This is the perfect valve for DIYs! All materials used to manufacture the valves meet ASTM standards. Available in 1½” and 2” sizes in White and Clear PVC.



PART NUMBER	SIZE & DETAIL DESCRIPTION	SPRING TENSION	IPS SIZE	QTY CASE	WT CASE
<b>0821-15H</b>	1½” Slip x 1½” Slip Hose Clamp Check Valve	½ lb.	1½”	12	14
<b>0821-15HC</b>	1½” Slip x 1½” Slip Hose Clamp Ck. Valve Clear	½ lb.	1½”	12	14
<b>0821-20H</b>	2” Slip x 2” Slip Hose Clamp Check Valve	½ lb.	2”	12	26
<b>0821-20HC</b>	2” Slip x 2” Slip Hose Clamp Ck. Valve Clear	½ lb.	2”	12	26

## Slide-Check & Ball-Check Combo Valves

Magic Plastics’ compact Slide-Check and Ball-Check Combo Valves combine the Valve and a “Smart” Check Valve in the same unit; saving you both excess time and labor during installation. The design of the “Smart” Check Valve will eliminate water hammer noise while also providing you with the luxury of installing the valve in either orientation, horizontally or vertically. Easy connection Buttress Thread Unions allow for cleaning of both valves when necessary. Slide-Check Combo Valves come equipped with the MagicSnap External Valve Lock to prevent accidental closure. All Slide-Check and Ball-Check Combo Valves are made from PVC and meet ASTM standards. Available in 1½” and 2” Slip configurations.

**WATERPROOF**



Slide-Check



Ball-Check

PART NUMBER	SIZE & DETAIL DESCRIPTION	QTY CASE	WT CASE
<b>0850-15</b>	1½” Slip x Slip Slide-Check Combo Valve	12	24
<b>0850-15C</b>	1½” Slip x Slip Slide-Check Combo Valve Clear	12	24
<b>0850-20</b>	2” Slip x Slip Slide-Check Combo Valve	12	36
<b>0850-20C</b>	2” Slip x Slip Slide-Check Combo Valve Clear	12	36
<b>0860-15</b>	1½” Slip x Slip Ball-Check Combo Valve	12	28
<b>0860-15C</b>	1½” Slip x Slip Ball-Check Combo Valve Clear	12	28
<b>0860-20</b>	2” Slip x Slip Ball-Check Combo Valve	12	42
<b>0860-20C</b>	2” Slip x Slip Ball-Check Combo Valve Clear	12	42

## “CR2®” Corrosion Resistant Check Valves

The “CR2®” Back-Flow prevention check valve is completely corrosion resistant, making it the ultimate solution for protecting your expensive Heat Exchangers from the potential damage of inline Chlorinators while also maintaining a Full-Flow circulation system. Numerous features are included with the “CR2®” Valve including a proprietary designed Hastelloy® Spring, Glass-Filled Noryl injection molded shaft, 100% Silicone Gasket and a Clear, serviceable lid. The “CR2®” Valve is also equipped with a ½ lb. spring-loaded gate, allowing it to be installed in any orientation. The “CR2®” valve is available in 1½” Slip, 2” Slip and 2½” Spigot. Economy version without Hastelloy® Spring available.



PART NUMBER	PART DESCRIPTION	IPS SIZE	QTY CASE	WT CASE
<b>CR2® Valve</b>				
<b>0801-20H2</b>	CPVC	2"	12	14

<b>Economy Valve</b>				
<b>0801-20</b>	ECONOMY	2"	12	14

0801-20 Not Equipped with Hastelloy® Spring

PART NUMBER	SIZE & DETAIL DESCRIPTION	QTY CASE
<b>0060104028</b>	Adapter, 2" Spigot x 1½" Slip White	24
<b>0061304028</b>	Adapter, 2" Spigot x 1½" Slip Black	24

\*1½" Bushings Sold Separately.

## Check Valve Replacement Components

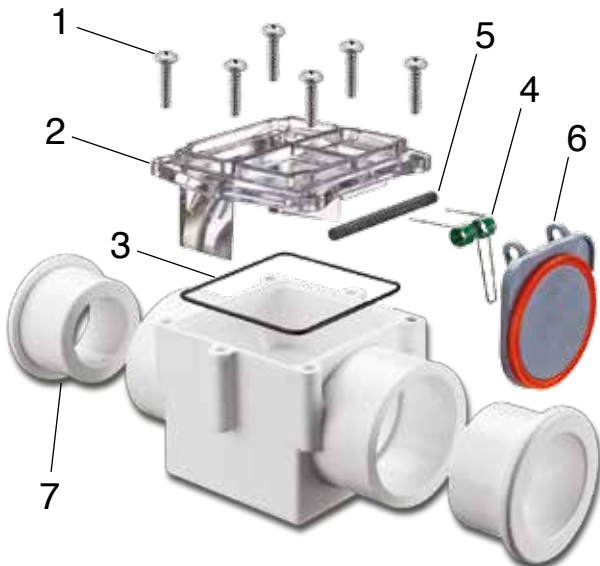

ID	PART NUMBER	SIZE & DETAIL DESCRIPTION	PKG QTY
1	<b>0403-006-6</b>	#14 x 1" Phillips Pan Head Stainless Metal Screw	6
2	<b>0191401020</b>	Lid, 2" Swing-Spring Check Valve	1
3	<b>0301-154</b>	O-Ring, 2" Swing-Spring Check Valve	1
4	<b>0405-001</b>	Spring, 2" Swing-Spring Check Valve	1
4	<b>0405-001-H</b>	Hastelloy Spring	1
5	<b>0401-005P</b>	Shaft, 2" Swing-Spring Check Valve	1
6	<b>0081201020</b>	Gate Assembly, 2" Swing-Spring Check Valve	1
7	<b>0060104028</b>	Adapter, 2" Spigot x 1½" Slip White	1
7	<b>0061304028</b>	Adapter, 2" Spigot x 1½" Slip Black	1
RK	<b>0801-20H-RK</b>	Replacement Kit, Check Valve Contains ID# 2, 3, 4(H), 5 & 6	1

## Utility Molded-In-Place Ball Valves

Specifically designed for Residential, Commercial and Industrial applications, the Magic MIP Ball Valves are equipped with EPDM Seats and O-Rings, providing smooth operation and excellent chemical resistance. All Valves comply with ASTM 2467 Standards and operate at a working pressure of 150 PSI at 73°F. Magic MIP Ball Valves are available in ½" through 3" Slip x Slip configurations.

Threaded configurations and larger sizes (4", 6" and 8") are available upon request. Minimum order quantities apply. Please contact the factory direct for details.



PART NUMBER	SIZE & DETAIL DESCRIPTION	QTY CASE	WT CASE
<b>0250-05</b>	½" Slip x Slip Ball Valve	36	6
<b>0250-07</b>	¾" Slip x Slip Ball Valve	18	5
<b>0250-10</b>	1" Slip x Slip Ball Valve	25	11
<b>0250-15</b>	1½" Slip x Slip Ball Valve	12	12
<b>0250-20</b>	2" Slip x Slip Ball Valve	8	11
<b>0250-25</b>	2½" Slip x Slip Ball Valve	6	25
<b>0250-30</b>	3" Slip x Slip Ball Valve	6	26

## Uni-Body Valves

The innovative patented design of the Magic Uni-Body valve was engineered for use in a wide variety of industries and applications. The built in Snap-Lock guarantees zero flow restriction during operation while the Cam-Lock function provides a 100% positive seal when shutoff is required. We have also added a specially formulated dry lubricant to our Seals and then overmold them directly to the valve gate, eliminating the need to repair or replace the gate seals. The Magic Uni-Body valve is available in a variety of configurations in 1", 1½", 2" and 2½" IPS sizes.



### Slip x Slip

PART NUMBER	IPS SIZE	QTY CASE/ MASTER	WT CASE/ MASTER
<b>0401-10</b>	1"	14/56	8/34
<b>0401-15</b>	1½"	14/56	9/36
<b>0401-20</b>	2"	12/48	10/41
<b>0401-25</b>	2½"	5/20	8/33



### Slip Union x Slip Union

PART NUMBER	IPS SIZE	QTY CASE/ MASTER	WT CASE/ MASTER
<b>0501-15</b>	1½"	6/24	7/28
<b>0501-20</b>	2"	6/24	10/41

**WIBPROOF**



## Uni-Body Valves



### Slip x Spigot

PART NUMBER	IPS SIZE	QTY CASE/ MASTER	WT CASE/ MASTER
<b>0412-15</b>	1½"	14/56	8/33
<b>0412-20</b>	2"	12/48	10/39
<b>0412-25</b>	2½"	5/20	8/30



### Spigot x Spigot

PART NUMBER	IPS SIZE	QTY CASE/ MASTER	WT CASE/ MASTER
<b>0402-15</b>	1½"	14/56	7/30
<b>0402-20</b>	2"	12/48	9/37
<b>0402-25</b>	2½"	5/20	8/30



### Slip x Union

PART NUMBER	IPS SIZE	QTY CASE/ MASTER	WT CASE/ MASTER
<b>0516-15</b>	1½"	10/40	9/36
<b>0516-20</b>	2"	10/40	12/49
<b>0516-25</b>	2½"	5/20	10/40

**WIDE PROOF**



### Spigot x Slip Union

PART NUMBER	IPS SIZE	QTY CASE/ MASTER	WT CASE/ MASTER
<b>0517-15</b>	1½"	10/40	8/31
<b>0517-20</b>	2"	10/40	12/49
<b>0517-25</b>	2½"	5/20	10/39

**WIDE PROOF**



### Slip x FIPT

PART NUMBER	IPS SIZE	QTY CASE/ MASTER	WT CASE/ MASTER
<b>0414-15</b>	1½"	14/56	9/36



### Slip x MIPT

PART NUMBER	IPS SIZE	QTY CASE/ MASTER	WT CASE/ MASTER
<b>0413-15</b>	1½"	14/56	9/36



### Spigot x FIPT

PART NUMBER	IPS SIZE	QTY CASE/ MASTER	WT CASE/ MASTER
<b>0424-15</b>	1½"	14/56	8/32



### MIPT x MIPT

PART NUMBER	IPS SIZE	QTY CASE/ MASTER	WT CASE/ MASTER
<b>0403-15</b>	1½"	14/56	9/35



### MIPT x FIPT

PART NUMBER	IPS SIZE	QTY CASE/ MASTER	WT CASE/ MASTER
<b>0434-15</b>	1½"	14/56	9/35
<b>B434-15</b>	1½"	14/56	9/35

B434-15=BLACK

## Uni-Body Valves



**Slip x Swivel FBT**

PART NUMBER	IPS SIZE	QTY CASE/ MASTER	WT CASE/ MASTER
<b>0550-15</b>	1½"	10/40	10/40
<b>0550-20</b>	2"	10/40	13/50

**WIDE PROOF**



**Slip Union x MIPT**

PART NUMBER	IPS SIZE	QTY CASE/ MASTER	WT CASE/ MASTER
<b>0435-15</b>	1½"	10/40	8/31

**WIDE PROOF**



**Pool Hose x MIPT**

PART NUMBER	IPS SIZE	QTY CASE/ MASTER	WT CASE/ MASTER
<b>0423-15</b>	1½"	14/56	8/32
<b>B423-15</b>	1½"	14/56	8/32

B423-15=BLACK



**Slip x MBT w/Washer Ring**

PART NUMBER	IPS SIZE	QTY CASE/ MASTER	WT CASE/ MASTER
<b>0556-20</b>	2"	12/48	11/38

Equipped with washer ring only.

## Metric Uni-Body Valves



**Slip x Slip**

PART NUMBER	IPS SIZE	QTY CASE/ MASTER	WT CASE/ MASTER
<b>M401-15</b>	50MM	14/56	9/36
<b>M401-20</b>	63MM	12/48	10/41

Minimum order 500. This is not a stock item.

## 90° On/Off Valve

Magic Plastics' 90° On-Off Valve is the perfect valve for spa side operation of waterfalls, neck jets or just about any other water feature in the spa. Unlike other valves of this type, Magic's 90° On-Off valve is Full-Flow and requires only 3 full turns to open or close the valve.



PART NUMBER	IPS SIZE	QTY CASE/ MASTER	WT CASE/ MASTER
<b>0230-10</b>	1"	48/96	20/40

*Custom cap colors and designs available. Contact factory for details and minimum order requirements.*

## External Valve Locks

All of Magic Plastics' Uni-Body Valves are equipped with an internal patented Snap-Lock open feature. Three-Piece valves do not have this option. Magic Plastics' External Valve Locks prevent accidental closure of the Three-Piece valve and provides additional security for the Uni-Body valves. All External Valve Locks come packaged in bags of 24 and are available in 1½", 2" and 2½".

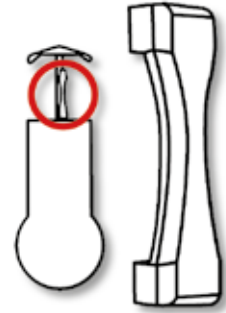

PART NUMBER	SIZE & DETAIL DESCRIPTION	PKG QTY
<b>0305-15</b>	1½" MagicSnap External Valve Lock	24
<b>0305-20</b>	2" MagicSnap External Valve Lock	24
<b>0305-25</b>	2½" MagicSnap External Valve Lock	24

*(Please note that all Uni-Body Valves are equipped with a patented internal snap-lock to prevent accidental closure.)*

## Spa Drain Valves

Simplify your servicing needs with Magic Plastics' patented Drain Valve. Manufactured from impact modified ABS and equipped with a total of 5 Teflon Impregnated O-Rings, the Magic Drain Valve is accessible to the consumer and simple to use. Designed for Skirt or Kick-Plate installations, the Drain Valve is flush mounted to the wall and secured in the closed position.

To operate, pull the spout out, leaving the exterior end cap on. Once extracted, by design, the Drain Valve will stay in the closed position. After the garden hose is installed, push the spout back in halfway to actuate the drain. The valve is also equipped with a removable bezel in order for the skirt to be detached without disturbing the plumbing. The Magic Drain Valve also has built in freeze protection and will drain approximately 5 gallons per minute. Available in ½" Slip, ¾" Barb or ¾" Spigot configurations. For detailed illustrated instructions, visit our download center at [www.magicplastics.com](http://www.magicplastics.com).



PART NUMBER	SIZE & DETAIL DESCRIPTION	QTY CASE
<b>0455-05</b>	½" Slip Spa Drain Valve	54
<b>0456-05</b>	¾" Barbed Spa Drain Valve	54
<b>0457-05</b>	¾" Spigot Spa Drain Valve	54

## Compact Air Check Valves

Magic Plastics' redesigned Compact Air Check Valve is ideal for all Spa, Jetted Tub and Pool applications. The Air Check Valve is equipped with a light ¼ lb. Stainless Steel Spring and a 100% Silicone Seal. The true compact design will save valuable space, especially where two valves are required in tandem. The redesigned internal components improve flow and reduce restriction, providing a quiet and smooth operation, virtually eliminating possible valve chatter during shutdown. Available in 1½" Slip - 2" Spigot in PVC and Polycarbonate Clear for higher heat applications and improved clarity.



PART NUMBER	SIZE & DETAIL DESCRIPTION	PKG QTY
<b>0830-15</b>	1½" Slip x 2" Spigot ¼ lb. Compact Air Check Valve	45
<b>0830-15C</b>	1½" Slip x 2" Spigot ¼ lb. Compact Air Check Valve (Clear PC)	45

## MagicVac

The MagicVac is operated by placing your thumb over the ergonomic air hole located at the top of the Vac, submerging it near the area to be cleaned, then releasing your thumb. A rush of water and debris will fill the clear, UV stabilized chamber. Raise the full chamber above the water line and allow it to drain, away from the spa. Virtually all debris will remain trapped in the built in removable filter. Detach the End Cap with a simple quarter turn and empty the debris. The MagicVac picks up sand, pebbles, even small rocks. You will be able to reach areas in excess of seven feet away with the telescoping aluminum pole. The MagicVac is completely serviceable and weighs less than two pounds.



PART NUMBER	SIZE & DETAIL DESCRIPTION	QTY CASE
<b>0690-1GEN</b>	MagicVac, Individual Box	1
<b>0690-12GEN</b>	MagicVac, 12-Pack Individually Packaged	1

# 90° SWEEPS • SPA COMPONENTS & WHITE GOODS

## 90° Sweeps

Magic Plastics' Sweep 90° Fittings and assemblies are designed to maximize flow and minimize restriction. Available in a variety of configurations in 2" IPS sizes, Magic's Sweep 90°s will provide you with the best performance in the industry while meeting all of your plumbing requirements. All 90° Sweeps are manufactured from quality PVC.

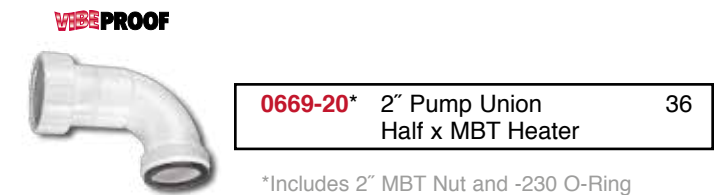
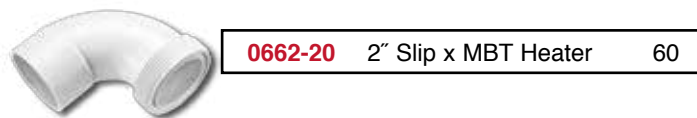
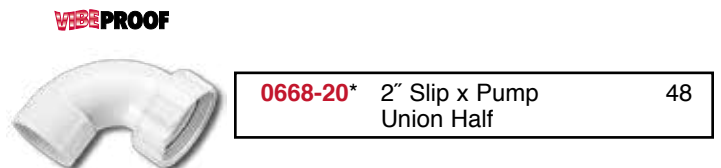
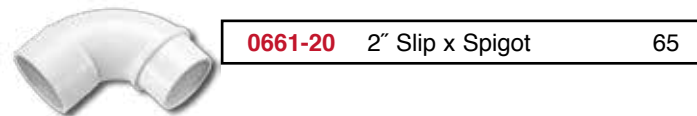
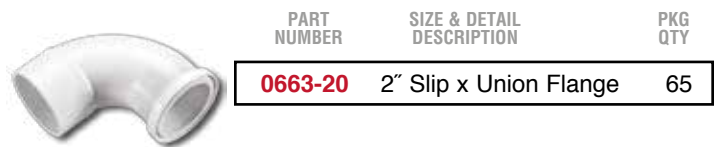
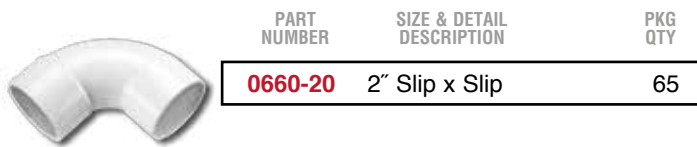

## Spa Components & White Goods

Magic Plastics continues to expand our line of Spa Components. Contact the factory if you require an item or configuration that is not listed below or in our catalog of products. Magic Plastics is continually growing our line of products and will consider your product or component based on volume.

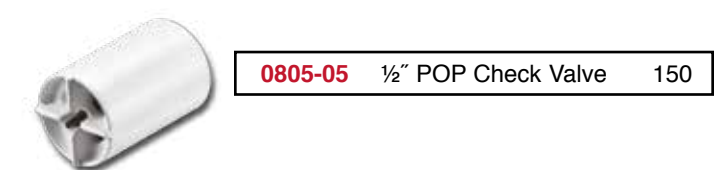
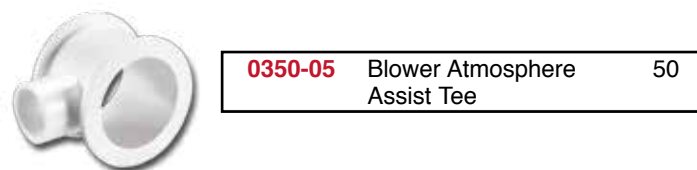
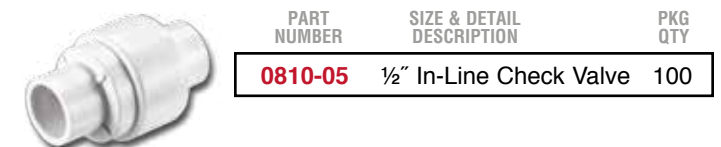



## Manifolds

Easily fabricate custom stack lengths with our complete line of Water and Air Manifolds. Precision barb fittings assure a permanent seal. The compact designs of our Manifolds are ideal for space limitations. All Manifolds utilize standard Clear Vinyl Tubing. Custom configurations are available, contact the factory for details.



PART NUMBER	SIZE & DETAIL DESCRIPTION	PKG QTY
<b>0320-05</b>	1/2" 7-Port Air Manifold	50

Includes 2 Plugs



PART NUMBER	SIZE & DETAIL DESCRIPTION	PKG QTY
<b>0341-10</b>	1" Slip x Slip 6-Port Air Manifold	60

Accepts 3/8" vinyl tubing.



PART NUMBER	SIZE & DETAIL DESCRIPTION	PKG QTY
<b>0342-10</b>	1" Slip x Slip 8-Port Air Manifold	60

Accepts 3/8" vinyl tubing.



PART NUMBER	SIZE & DETAIL DESCRIPTION	PKG QTY
<b>0343-10</b>	1" Slip x Slip 10-Port Air Manifold	60

Accepts 3/8" vinyl tubing.



PART NUMBER	SIZE & DETAIL DESCRIPTION	PKG QTY
<b>0330-05</b>	1/2" MPT 3-Port Air Intake Manifold	75

Accepts 3/4" vinyl tubing – threads are 1/2" MPT.



PART NUMBER	SIZE & DETAIL DESCRIPTION	PKG QTY
<b>0388-15</b>	1 1/2" Slip x Slip 6-Port Water Manifold	50
<b>0386-15</b>	1 1/2" Slip x Spigot 6-Port Water Manifold	50

Includes 2 plugs – ports are 1/2" slip.



PART NUMBER	SIZE & DETAIL DESCRIPTION	PKG QTY
<b>0361-20</b>	2" Slip x Slip 2-Port Barbed Water Manifold	100
<b>0362-20</b>	2" Slip x Spigot 2-Port Barbed Water Manifold	100

Accepts 3/4" vinyl tubing.



PART NUMBER	SIZE & DETAIL DESCRIPTION	PKG QTY
<b>0363-20</b>	2" Slip x Dead End 2-Port Barbed Water Manifold	150

Accepts 3/4" vinyl tubing.



PART NUMBER	SIZE & DETAIL DESCRIPTION	PKG QTY
<b>0369-20</b>	2" Slip x Slip 4-Port Barbed Water Manifold	70
<b>0364-20</b>	2" Slip x Spigot 4-Port Barbed Water Manifold	66

Accepts 3/4" vinyl tubing.



PART NUMBER	SIZE & DETAIL DESCRIPTION	PKG QTY
<b>0365-20</b>	2" Slip x Dead End 4-Port Barbed Water Manifold	90

Accepts 3/4" vinyl tubing.



PART NUMBER	SIZE & DETAIL DESCRIPTION	PKG QTY
<b>0368-20</b>	2" Slip x Slip 6-Port Barbed Water Manifold	50
<b>0366-20</b>	2" Slip x Spigot 6-Port Barbed Water Manifold	50

Accepts 3/4" vinyl tubing.



PART NUMBER	SIZE & DETAIL DESCRIPTION	PKG QTY
<b>0367-20</b>	2" Slip x Dead End 6-Port Barbed Water Manifold	60

Accepts 3/4" vinyl tubing.



PART NUMBER	SIZE & DETAIL DESCRIPTION	PKG QTY
<b>0321-10</b>	3-in-1 1" 12-Port Air Manifold	50

Accepts 3/8" vinyl tubing. Includes 2 end caps and 4 plugs. Stackable.



PART NUMBER	SIZE & DETAIL DESCRIPTION	PKG QTY
<b>0360-00</b>	2" Water Manifold Plug	100

## MagicMend® Pipe Extenders

Save valuable fittings and time with the MagicMend® Pipe Extenders. The MagicMend® is extremely effective and easy to use. Simply cut the defective fitting from the system, remove it and install the Extender. The MagicMend® will work at any glued plumbing joint, providing a permanent, invisible repair with insignificant flow restriction. The MagicMend® is available in 1/2" through 4" IPS sizes for Schedule 40 Pipe and 1", 1 1/4", 1 1/2" and 2" sizes for Class 200 Pipe.



PART NUMBER	IPS SIZE	QTY CASE	WT CASE
<b>MagicMend® Pipe Extenders - Schedule 40</b>			
<b>0301-05</b>	1/2"	48	2
<b>0301-07</b>	3/4"	48	2
<b>0301-10</b>	1"	48	3
<b>0301-12</b>	1 1/4"	48	5
<b>0301-15</b>	1 1/2"	48	5
<b>0301-20</b>	2"	48	8
<b>0301-25</b>	2 1/2"	48	18
<b>0301-30</b>	3"	48	22
<b>0301-40</b>	4"	48	36

Slips inside Schedule 40 pipe.



PART NUMBER	IPS SIZE	QTY CASE	WT CASE
<b>MagicMend® Pipe Extenders - Class 200</b>			
<b>0304-10</b>	1"	48	3
<b>0304-12</b>	1 1/4"	48	5
<b>0304-15</b>	1 1/2"	48	5
<b>0304-20</b>	2"	48	8

Slips inside Class 200 pipe.

## MagicMend® Extender Fittings

The MagicMend® Extender Fitting is designed to glue over fittings where there is not a sufficient amount of pipe left for a connection. Simply remove any excess pipe and connect the MagicMend® by gluing over the existing fitting. The opposite end of both the 1 1/2" and 2" Extender Fitting will accept either 1 1/2" pipe or a 2" fitting so you have the option of continuing the plumbing with either pipe size. The MagicMend® Extender Fittings are available in 1 1/2" and 2" IPS sizes.



PART NUMBER	IPS SIZE	QTY CASE	WT CASE
<b>MagicMend® Extender Fittings</b>			
<b>0303-15</b>	1 1/2"	48	11
<b>0303-20</b>	2"	48	15

Fits over 1 1/2" or 2" fittings.

# REPAIR FITTINGS • ADAPTERS

## MagicMend® Insider Connectors

Why use an additional fitting when you can use a MagicMend® Insider Connector? The MagicMend® Insider Connector will join two pieces of PVC Schedule 40 pipe together. Should a pipe be cut off flush with concrete or buried underground, a MagicMend® will easily solve the problem. The MagicMend® Insider Connectors are available in 1", 1¼", 1½", 2", 3" and 4" IPS sizes.



PART NUMBER	IPS SIZE	QTY CASE	WT CASE
<b>MagicMend® Insider Connectors</b>			
<b>0302-10</b>	1"	48	3
<b>0302-12</b>	1¼"	48	5
<b>0302-15</b>	1½"	48	6
<b>0302-20</b>	2"	48	9
<b>0302-30</b>	3"	48	20
<b>0302-40</b>	4"	48	34

Connects Schedule 40 pipe.

## Copper-To-PVC Adapters

This is the ideal fitting for an easy and smooth transition from Copper to PVC pipe. Fittings are assembled with Buna-70 O-Rings that provide a positive water tight seal and also an internal Stainless Steel gripper ring to prevent the pipe from pulling out, ensuring a solid connection. Available in 1½" and 2" IPS sizes.



PART NUMBER	SIZE & DETAIL DESCRIPTION	PKG QTY	WT
<b>0606-15</b>	1½" Slip - 2" Spigot Copper-to-PVC Adapter	24	13
<b>0606-20</b>	2" Slip Copper-to-PVC Adapter	18	11

## Heater-Pump Adapters

Magic's Adapter Bushings are designed to increase a 1½" MBT fitting to a 2" MBT fitting simply by threading the adapter to the female threaded fitting. The internal thread of the bushing is 1½" FBT with an O-ring (included), ensuring a positive seal. The external thread is 2" FBT. You can choose from two configurations, one with O-ring groove for Heater applications and one without O-ring groove for Pump Union applications. Adapters are manufactured from quality PVC.



PART NUMBER	SIZE & DETAIL DESCRIPTION	PKG QTY	WT
<b>0060150019</b>	Adapter, 1½" FBT x 2" MBT w/O-Ring Groove	228	48
<b>0060151019</b>	Adapter, 1½" FBT x 2" MBT	228	49

## Union Assemblies

Easy Connection Buttress Threads and deep socket connections with glue traps make the Magic Union Assemblies reliable and leak free. In addition, Magic Plastics' Unions are also equipped with our Pat. Pending Vibeproof® Technology. Magic Union Assemblies are available in a variety of configurations in 1½", 2" and 2½" IPS sizes.



PART NUMBER	SIZE & DETAIL DESCRIPTION	PKG QTY
<b>0602-15</b>	1½" Pump Union Half	115
<b>0602-20</b>	2" Pump Union Half	72
<b>0602-25</b>	2½" Pump Union Half	50



<b>0604-20</b>	2" 45° Spigot Union Half	50
<b>0605-20</b>	2" 45° Slip Union Half	50



<b>0611-15</b>	1½" Slip Heater Union Half w/Split Nut	50
<b>0611-18</b>	1½" Slip-2" Spigot Heater Union Half w/Split Nut	50
<b>0611-20</b>	2" Slip Heater Union Half w/Split Nut	50



<b>0650-15</b>	1½" Slip x Slip Self-Aligning Union Assembly	50
<b>0650-18</b>	2" Slip x 1½" Slip-2" Spigot Self-Aligning Union Assembly	25
<b>0650-20</b>	2" Slip x Slip Self-Aligning Union Assembly	25

## High Heat Union Assemblies

Magic Plastics' Self-Sealing High-Heat Unions prevent plumbing failures due to extreme heat buildup caused by the Pump running dry. Made from durable GFN3, the High-Heat Unions include a positive O-Ring seal, eliminating the need for additional thread sealants. The Unions also incorporate Magic Plastics' Pat. Pending Vibeproof® Technology. Available in 1½" and 2" IPS sizes and rated at 175 PSI @ 75°F.



PART NUMBER	SIZE & DETAIL DESCRIPTION	PKG QTY
<b>0615-15</b>	1½" MIP x 1½" Slip - 2" Spigot High-Heat Union Assembly	27



<b>0615-20</b>	2" MIP x 2" Slip High-Heat Union Assembly	36
----------------	---	----

# UNION ASSEMBLIES • UNION COMPONENTS

## High Heat Union Assemblies

**WIREPROOF**



PART NUMBER	SIZE & DETAIL DESCRIPTION	PKG QTY
<b>0615-20S</b>	2" MIP x 2" Slip Sweep High-Heat Union Assembly	25

## Union Components

All Magic Plastics Union Components are manufactured from quality PVC or ABS. Magic Union Components come bulk packaged and are available in 1½", 2" and 2½" IPS sizes.



PART NUMBER	SIZE & DETAIL DESCRIPTION	PKG QTY
<b>0120103015</b>	1½" FBT Union Nut	135
<b>0120103020</b>	2" FBT Union Nut	90
<b>0120103025</b>	2½" FBT Union Nut	50



<b>0121109015</b>	1½" FBT Repair Split Nut Set w/Screws	125
<b>0121109020</b>	2" FBT Repair Split Nut Set w/Screws	100
<b>0121109025</b>	2½" FBT Repair Split Nut Set w/Screws	74



<b>0050103015</b>	1½" Slip Tailpiece with O-Ring Groove	184
<b>0050103020</b>	2" Slip Tailpiece with O-Ring Groove	112
<b>0050103025</b>	2½" Slip Tailpiece with O-Ring Groove	100



<b>0050104020</b>	2" 45° Spigot Tailpiece with O-Ring Groove	100
<b>0050104520</b>	2" 45° Slip Tailpiece with O-Ring Groove	100



<b>0050105015</b>	1½" MBT x 1½" Slip Tailpiece	100
<b>0050105018</b>	2" MBT x 1½" Slip-2" Spigot Tailpiece	100
<b>0050105020</b>	2" MBT x 2" Slip Tailpiece	100

All Union Components Utilize O-Rings: 1½" - 225 2" - 230 2½" - 234

MBT = Male Buttress Threads

FBT = Female Buttress Threads



# SNAP NUTS • UNION COMPONENTS

## Snap Nuts

Magic Plastics' Snap Nut is uniquely designed to be used on SS heater housings as an alternative to a Split Nut. The Snap Nut eliminates the need for additional hardware, allowing for installation in a fraction of the time. No tools are required! The Snap Nut is manufactured from quality ABS and is available in 1½" and 2" sizes.



PART NUMBER	SIZE & DETAIL DESCRIPTION	PKG QTY
<b>C015C</b>	1½" Snap Nut Clip	350
<b>C015N</b>	1½" Snap Nut	100
<b>C020C</b>	2" Snap Nut Clip	350
<b>C020N</b>	2" Snap Nut	100

Clip and Nut must be purchased as a set.

## Heater Union Components

All Magic Plastics Heater Union Components are manufactured from quality PVC or ABS. Magic Heater Union Components are bulk packaged and are available in 1½" MBT and 2" MBT with ½" through 2" Slip ends and glue wells. Our Washer Rings are recommended for all Magic Heater Union Components and are sold separately.



PART NUMBER	SIZE & DETAIL DESCRIPTION	PKG QTY
<b>0050106007</b>	1½" MBT x ¾" Slip-1" Spigot Tailpiece with O-Ring Groove	100
<b>0050106010</b>	1½" MBT x 1" Slip Tailpiece with O-Ring Groove	100



<b>0050106007-OF</b>	1½" MBT x ¾" Slip-1" Spigot Tailpiece with O-Ring Groove (Offset)	100
<b>0050106010-OF</b>	1½" MBT x 1" Slip Tailpiece with O-Ring Groove (Offset)	100



<b>0050106012</b>	1½" MBT x 1¼" Slip Tailpiece with O-Ring Groove	100
<b>0050106015</b>	1½" MBT x 1½" Slip Tailpiece with O-Ring Groove	100
<b>0050106015-SH</b>	1½" MBT x 1½" Slip Tailpiece with O-Ring Groove (Short)	100



<b>0050107018</b>	2" MBT x 1½" Slip-2" Spigot Tailpiece with O-Ring Groove	100
<b>0050107020</b>	2" MBT x 2" Slip Tailpiece with O-Ring Groove	100
<b>0050107020-SH</b>	2" MBT x 2" Slip Tailpiece with O-Ring Groove (Short)	270



<b>0121108015</b>	1½" FBT Heater Split Nut Set w/Screws	125
<b>0121108020</b>	2" FBT Heater Split Nut Set w/Screws	100
<b>0121108025</b>	2½" FBT Heater Split Nut Set w/Screws	74

All Heater Union Components Utilize Washer Rings.  
 1½" MBT - 224 WR  
 2" MBT - 229 WR

MBT = Male Buttress Threads  
 FBT = Female Buttress Threads

# THREE PIECE VALVES • TANK ADAPTER VALVES

## Three Piece Valves

The Three-Piece Valve design can be easily disassembled, allowing you to clean and service the valve. The easy push-pull slide and 100% positive seal is ideal for a number of applications. Magic Three-Piece valves are available in a variety of configurations in both 1½" and 2" IPS sizes.



### Slip x Slip

PART NUMBER	IPS SIZE	QTY CASE/ MASTER	WT CASE/ MASTER
<b>0101-15</b>	1½"	12/48	10/42
<b>0101-20</b>	2"	12/48	13/50



### Slip x Spigot

PART NUMBER	IPS SIZE	QTY CASE/ MASTER	WT CASE/ MASTER
<b>0112-15</b>	1½"	12/48	10/40
<b>0112-20</b>	2"	12/48	12/48



### Spigot x Spigot

<b>0102-15</b>	1½"	12/48	10/38
<b>0102-20</b>	2"	12/48	12/47

## Tank Adapter Valves

Magic Plastics' Tank Adapter valves were designed specifically for bulkhead applications. Both standard and Low Profile designs are available in the popular Uni-Body style as well as the serviceable Three-Piece design. 1½" size, white or black.



### Slip x Tank Adapter Uni-Body

PART NUMBER	IPS SIZE	QTY CASE/ MASTER	WT CASE/ MASTER
<b>0416-15</b>	1½"	10/40	9/40
<b>B416-15</b>	1½"	10/40	9/40

B416-15=BLACK



### Slip x Tank Adapter

PART NUMBER	IPS SIZE	QTY CASE/ MASTER	WT CASE/ MASTER
<b>0116-15</b>	1½"	10/40	11/43
<b>0116-15LP</b>	1½"	10/40	10/41
<b>B116-15</b>	1½"	10/40	11/43
<b>B116-15LP</b>	1½"	10/40	10/41

B116-15 = Black  
0116-15LP = Low Profile

## Specialty Products



PART NUMBER	SIZE & DETAIL DESCRIPTION	PKG QTY
<b>0203-004</b>	2" Plug and Seal Ring - EPDM Seal	1



<b>0621-30</b>	3" Male Closet Flange	90
----------------	-----------------------	----



<b>0622-30</b>	3" Female Closet Flange	70
----------------	-------------------------	----



<b>0610-20</b>	2" 45° Drain Outlet Adapter	1
----------------	-----------------------------	---

# HOSE BIBBS • PVC UNIONS

## Hose Bibbs

Magic Plastics' Hose Bibbs are manufactured from quality PVC and are completely serviceable. Designed for use for temperatures up to 120° F at 150 PSI. Pipe and Hose Threads comply with ASTM standards. Available in 1/2" and 3/4".



PART NUMBER	IPS SIZE	QTY CASE/ MASTER	WT CASE/ MASTER
<b>PVC Hose Bibbs</b>			
<b>0203-05</b>	1/2"	48/192	8/35
<b>0203-07</b>	3/4"	48/192	8/36

## PVC Industrial Unions

All industrial unions are equipped with ACME threads and EPDM O-Rings. Available in 1/2" through 4" IPS sizes. 6" and 8" available, please contact the factory direct for pricing and lead-times.



PART NUMBER	SIZE & DETAIL DESCRIPTION	PKG QTY
<b>10650-05</b>	1/2" Union Assembly	48
<b>10650-07</b>	3/4" Union Assembly	48
<b>10650-10</b>	1" Union Assembly	48
<b>10650-15</b>	1 1/2" Union Assembly	48
<b>10650-20</b>	2" Union Assembly	24
<b>10650-25</b>	2 1/2" Union Assembly	12
<b>10650-30</b>	3" Union Assembly	12
<b>10650-40</b>	4" Union Assembly	8

## Expandable Repair Couplings

The Slip x Spigot design of the couplings allows for a quick, simple and permanent solution to repair broken pipes. You can also use the Expandable Coupling for a union in piping installations. The double O-Ring seal design provides added leak protection against pipe deflection and also insures smooth movement during installation. Expandable Repair Couplings are made from quality PVC and are available in ½" through 4" IPS sizes. 6" and 8" available, please contact the factory direct for pricing and lead-times.



PART NUMBER	SIZE & DETAIL DESCRIPTION	PKG QTY
<b>0620-05</b>	½" Expansion Coupling	48
<b>0620-07</b>	¾" Expansion Coupling	48
<b>0620-10</b>	1" Expansion Coupling	48
<b>0620-15</b>	1½" Expansion Coupling	24
<b>0620-20</b>	2" Expansion Coupling	24
<b>0620-30</b>	3" Expansion Coupling	12
<b>0620-40</b>	4" Expansion Coupling	6

## Compression Couplings

Our general use Compression Couplings are ideal for both repairs and installations. Santoprene gaskets provide a 100% maintenance-free seal. This is the perfect fitting for emergency situations, no solvent required. Compression Couplings are made from quality PVC and are available in ½" through 4" IPS sizes. 6" and 8" available, please contact the factory direct for pricing and lead-times.



PART NUMBER	SIZE & DETAIL DESCRIPTION	PKG QTY
<b>0630-05</b>	½" Compression Coupling	48
<b>0630-07</b>	¾" Compression Coupling	48
<b>0630-10</b>	1" Compression Coupling	48
<b>0630-15</b>	1½" Compression Coupling	24
<b>0630-20</b>	2" Compression Coupling	24
<b>0630-30</b>	3" Compression Coupling	12
<b>0630-40</b>	4" Compression Coupling	6



# O-RINGS • WASHER RINGS • MAGIC WRENCH

## O-Rings

All O-Rings are manufactured from Buna-70. Magic Plastics O-Rings fit the products listed in our catalog. Other suppliers may have variant O-Ring dimensions and specifications. Other materials are available upon request. Please contact the factory for details.



PART NUMBER	SIZE & DETAIL DESCRIPTION	PKG QTY
<b>0301-225-12</b>	Kit, O-Ring 1½" Union	12
<b>0301-229-12</b>	Kit, O-Ring 2" I.B.C. Valve	12
<b>0301-230-12</b>	Kit, O-Ring 2" Union	12
<b>0301-234-12</b>	Kit, O-Ring 2½" Union	12
<b>0301-223-12</b>	Kit, O-Ring 1½" Copper to PVC Adapter	12
<b>0301-227-12</b>	Kit, O-Ring 2" Copper to PVC Adapter	12

## Washer Rings

Magic Plastics Washer Rings are specifically designed to fit the Unions and Heater Union components and assemblies listed in our catalog.



PART NUMBER	SIZE & DETAIL DESCRIPTION	PKG QTY
<b>0301-224W-12</b>	Kit, Washer Ring 1½" Union	12
<b>0301-229W-12</b>	Kit, Washer Ring 2" Union	12
<b>0302-020B-12</b>	Kit, Washer Ring 2" Slip x MBT Valve	12

## Magic Wrench

The new Magic Wrench removes 9 different pump lids and numerous equipment lids. Don't risk damaging your pump lid by using hammers and 2 x 4's, safely remove your pump lids with the Magic Wrench. Manufactured from super-tough Glass Filled Nylon, the Magic Wrench is the perfect tool to carry with you on service calls.

To see the Magic Wrench in action, visit our download center at [www.magicplastics.com](http://www.magicplastics.com).



PART NUMBER	SIZE & DETAIL DESCRIPTION	PKG QTY
<b>PPTW</b>	Magic Wrench	12

# REPLACEMENT COMPONENTS

## Replacement Components



PART NUMBER	SIZE & DETAIL DESCRIPTION	PKG QTY
<b>0030101015</b>	Slip Flange 1 1/2"	1
<b>0030101020</b>	Slip Flange 2"	1
<b>0040101015</b>	Spigot Flange 1 1/2"	1
<b>0040101020</b>	Spigot Flange 2"	1



<b>0603-15</b>	1 1/2" Valve Body with Handle	1
<b>0603-20</b>	2" Valve Body with Handle	1



<b>0090101000</b>	Handle 1 1/2" & 2" (For Three-Piece Valve)	1
<b>0090102000</b>	Handle 1 1/2" & 2" Uni-Body	1
<b>0090102025</b>	Handle 2 1/2" Uni-Body	1



<b>0080301015-12</b>	Kit, Seals 1 1/2" Valve	12
<b>0080301020-12</b>	Kit, Seals 2" Valve	12



<b>0402-001-12</b>	Kit, Nut with Nylon Insert 10-24	12
<b>0403-001-12</b>	Kit, Screw Hex with Washer 10-24 x 13/8"	12



<b>0120102015</b>	Nut 1 1/2" MSPT with Flange White	1
<b>0120502000</b>	Nut 1 1/2" MSPT with Flange Black	1
<b>0302-002-12</b>	Kit, Flat Washer 1 1/2" Bulkhead Fitting	12

## I.B.C. Products

A number of products are available for this growing industry. The durable Uni-Body valve attaches to the I.B.C. liner by way of a union-like Buttress threaded Flange. A probe cutter allows the valve to be attached securely to the liner in any position, providing a positive seal connection before the liner membrane is pierced for evacuation. The I.B.C. Valve and Flanges are available in a variety of configurations. In addition, the Flanges are available in both PVC and LLDPE materials.



### IBC Valve

PART NUMBER	IPS SIZE	QTY CASE/ MASTER	WT CASE/ MASTER
<b>0504-20</b>	2"	10/40	11/44

Standard



### Buttress Plug

PART NUMBER	IPS SIZE	QTY CASE/ MASTER	WT CASE/ MASTER
<b>0703-20</b>	2"	125/500	16/65



### FIPT x FIPT Valve

<b>0404-20</b>	2"	12/48	9/37
----------------	----	-------	------



### Nut & Flange Assembly

<b>0706-20</b>	2"	108	34
<b>0708-20</b>	2"	108	39
<b>0709-20</b>	2"	108	39

(For Standard IBC Valve)

0706-20=LLDPE

0708-20=PVC

0709-20=SANTOPRENE



### MBT x MIPT/FIPT Valve

<b>0520-20</b>	2"	10/40	11/44
----------------	----	-------	-------



### FIPT Threaded Flange

<b>0705-20</b>	2"	144	23
<b>0707-20</b>	2"	144	29

0705-20=LLDPE

0707-20=PVC



### Probe Cutter

<b>0701-20</b>	2"	12/48	7/27
----------------	----	-------	------



### FBT Threaded Flange

<b>0710-00</b>	SPECIAL	108	23
<b>0711-00</b>	SPECIAL	108	30

0710-00=LLDPE

0711-00=PVC

## WARRANTY

WARRANTY FOR STANDARD PRODUCTS- Seller warrants all Seller products to be free from defects in materials and workmanship in normal use for a period of one (1) year from the date of invoice. If Customer receives defective goods or parts, Customer may send such defective goods or parts prepaid to Seller in Valencia, California accompanied by a letter stating the nature of the defect. After examination, if there is determined to be a defect in materials or workmanship, Seller shall, at its sole option and discretion, rework, repair or replace the defective goods or parts, or reimburse Customer for the cost of the goods or parts. All shipping costs for return of defective goods and replacements are the responsibility of Customer. Customer agrees that Seller will not be held responsible for parts or labor (other than Seller's parts and labor) in connection with reworking, repairing or replacing of such goods or parts. THE WARRANTY STATED ABOVE IS IN LIEU OF ALL OTHER WARRANTIES, CONDITIONS OR OTHER TERMS, EXPRESS OR IMPLIED, STATUTORY OR OTHERWISE, INCLUDING WITHOUT LIMITATION ANY IMPLIED WARRANTIES OF TERMS AS TO QUALITY, MERCHANTABILITY, FITNESS FOR PARTICULAR PURPOSE OR OTHERWISE, WHETHER IMPLIED BY CUSTOM OR LAW.

LIMITATION OF DAMAGES - IN NO EVENT SHALL SELLER BE LIABLE FOR ANY INDIRECT, INCIDENTAL, CONSEQUENTIAL, SPECIAL OR PUNITIVE DAMAGES OF ANY KIND OR NATURE ARISING OUT OF OR RELATING TO THE TRANSACTION CONTEMPLATED HEREBY OR TO THE MANUFACTURE, SALE, DELIVERY, RESALE, REWORK, REPAIR, REPLACEMENT, OR USE OF ANY PRODUCTS, WHETHER SUCH LIABILITY IS BASED IN CONTRACT, TORT, NEGLIGENCE, STRICT LIABILITY OR OTHERWISE, EVEN IF SELLER HAD BEEN WARNED OF THE POSSIBILITY OF ANY SUCH DAMAGES.

THE WARRANTIES AND DISCLAIMERS OF WARRANTIES SET FORTH HEREIN MAY NOT BE EXTENDED, ALTERED OR OTHERWISE MODIFIED EXCEPT BY WRITTEN INSTRUMENT SIGNED BY SELLER.

TERMS: NET 30 DAYS (O.A.C.)  
MINIMUM ORDER \$50.00 NET (CASE QUANTITY)  
LEAD TIME: 1-3 BUSINESS DAYS





**MAGIC PLASTICS, INC.**

25215 Ave. Stanford • Valencia, CA 91355

(661) 257-4485 • Toll Free (800) 369-0303

FAX (661) 257-1911

[www.magicplastics.com](http://www.magicplastics.com)

Email [sales@magicplastics.com](mailto:sales@magicplastics.com)